

! INFO !

Do not charge the battery of the towing vehicle and/or towed vehicle directly via the socket.

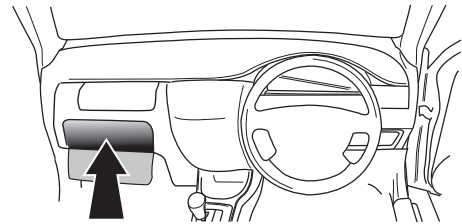

User guide



SPARE PARTS

www.ecs-electronicsuk.co.uk



Partnr.: JG-001-DHU

User Guide

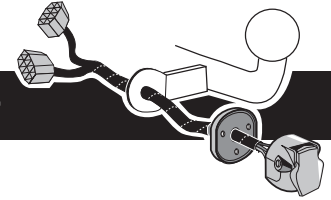

Jaguar X-Type Sedan/Saloon RHD 2002-

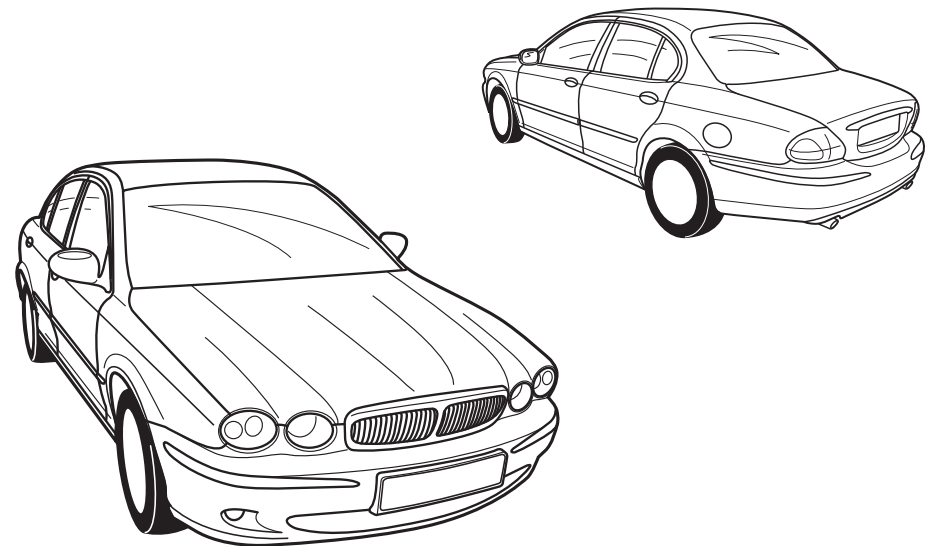

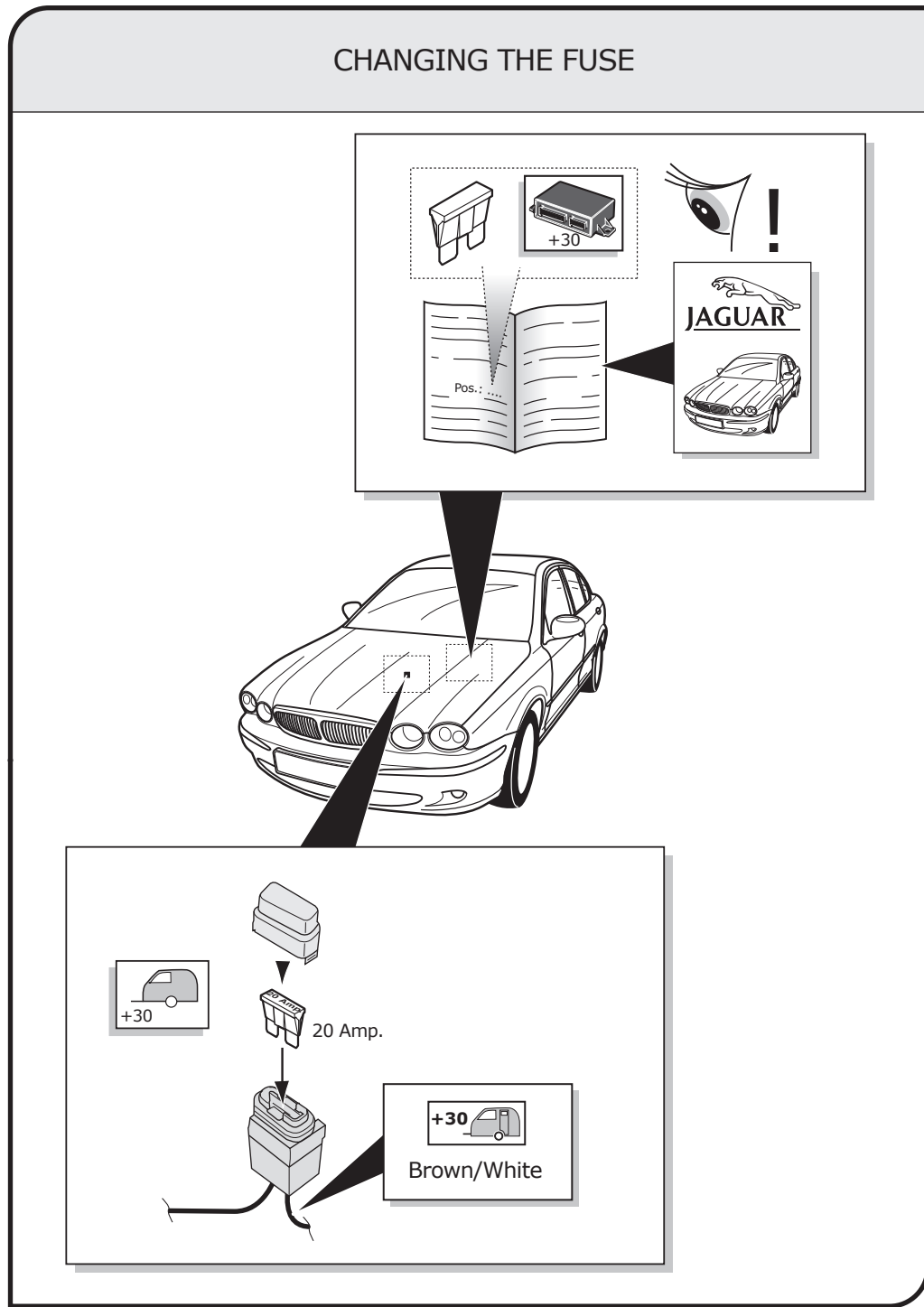
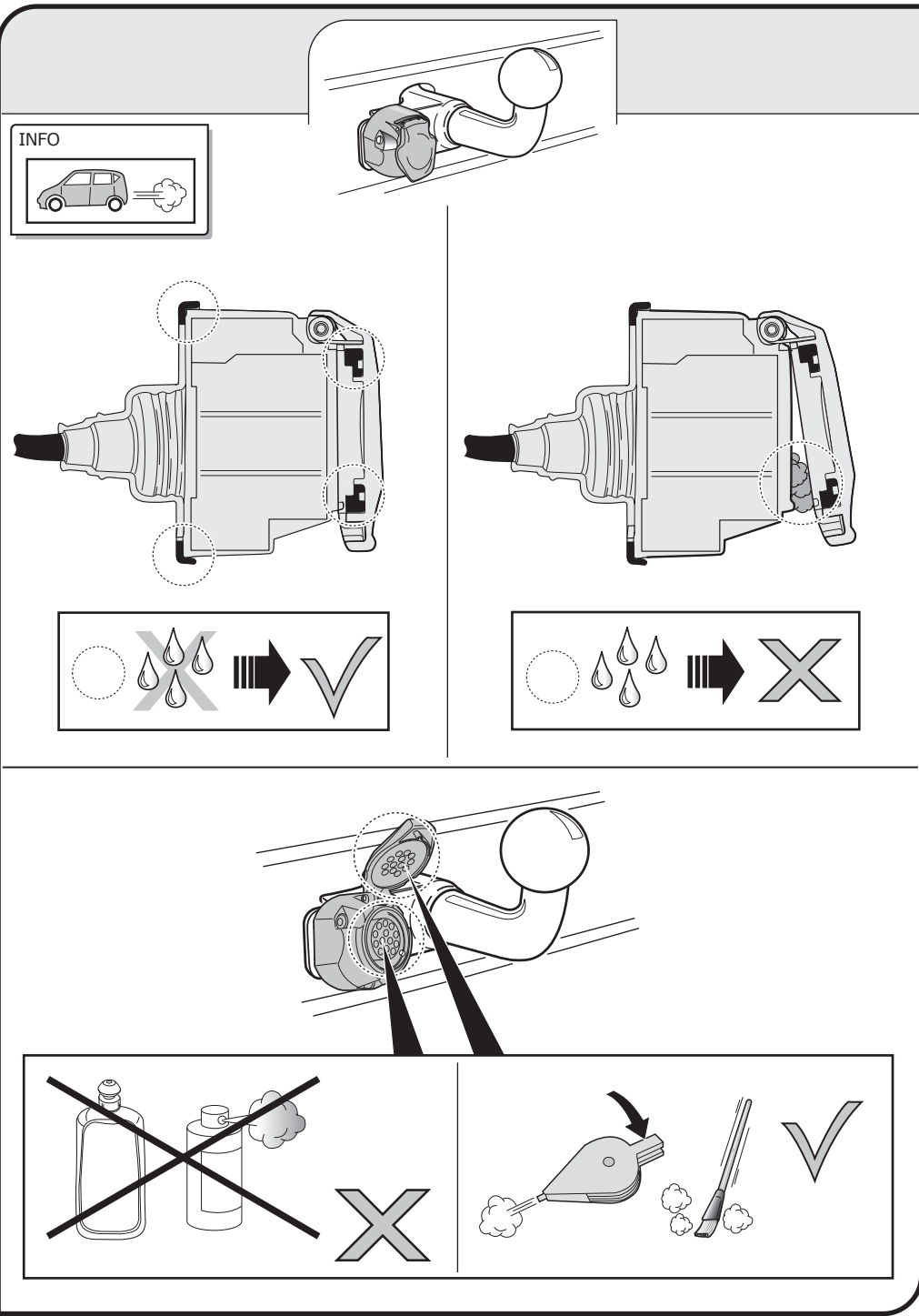

SOCKET CONNECTION

DIN/ISO 11446																
Pmax	21W	2x21W		21W	52W	3x21W	52W	2x21W	180W/15Amp	180W/15Amp						
Colour	Yellow	Blue	White	Green	Brown	Red 1,00 mm ²	Black	Black/ Red	Brown/ White	Red 2,50 mm ²	White	Red/ Blue	White			



In a coupled trailer with working fog lamp, the fog lamp of the vehicle will be switched off, if applicable.



The flashing lights on the trailer are monitored. If one of the indicators of the trailer breaks down, a buzzer will be audible and/or a visual signal will be visible on the dashboard. Check the flashing lights on the trailer.

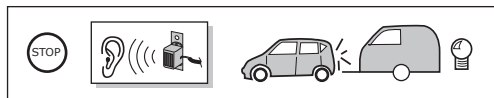

The brake lights on the trailer are monitored by the module. If all the brake lights on the trailer are defective, a buzzer is heard upon braking. Check the brake lights on the trailer.

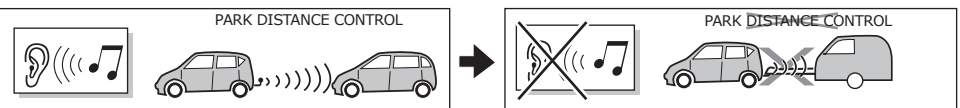

The wiring kit has a possibility to switch off any Park Distance Control in the case of a coupled trailer.

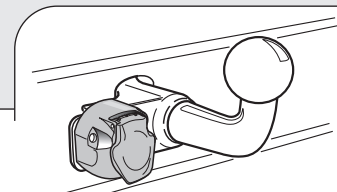

INFO : Ring.

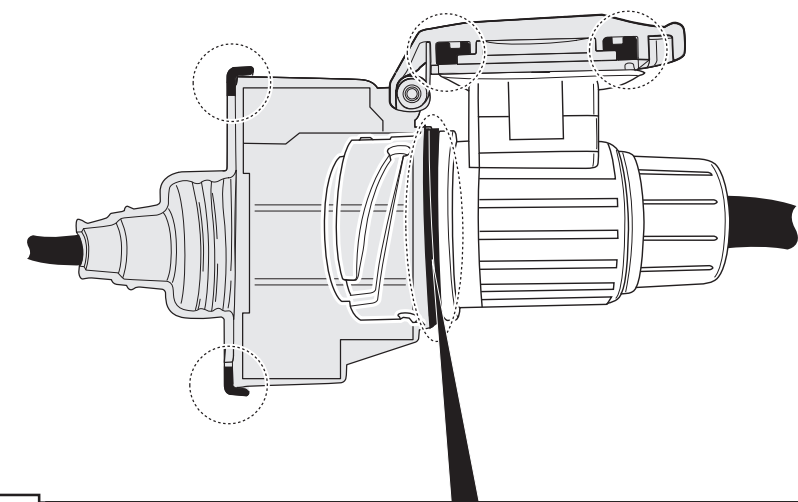
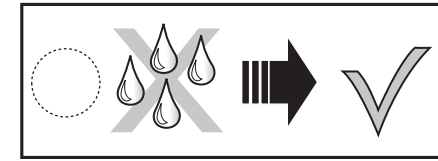
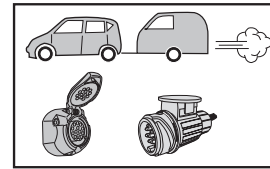

INFO

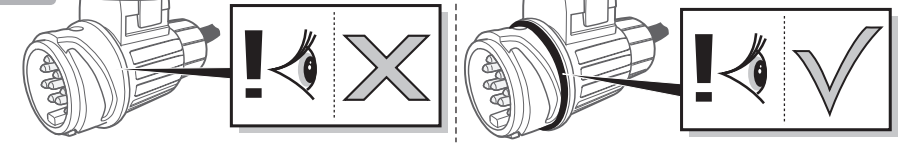

INFO : Adapt.

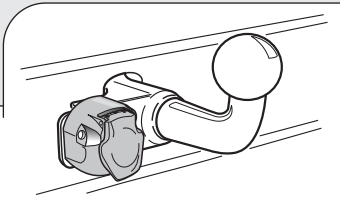
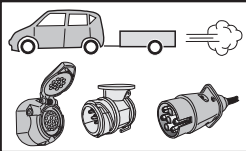

INFO

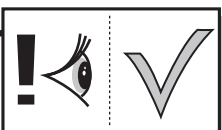
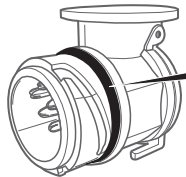
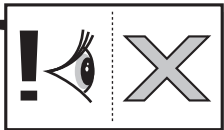
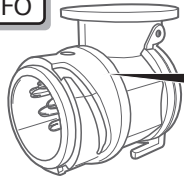

INFO : Storage

